

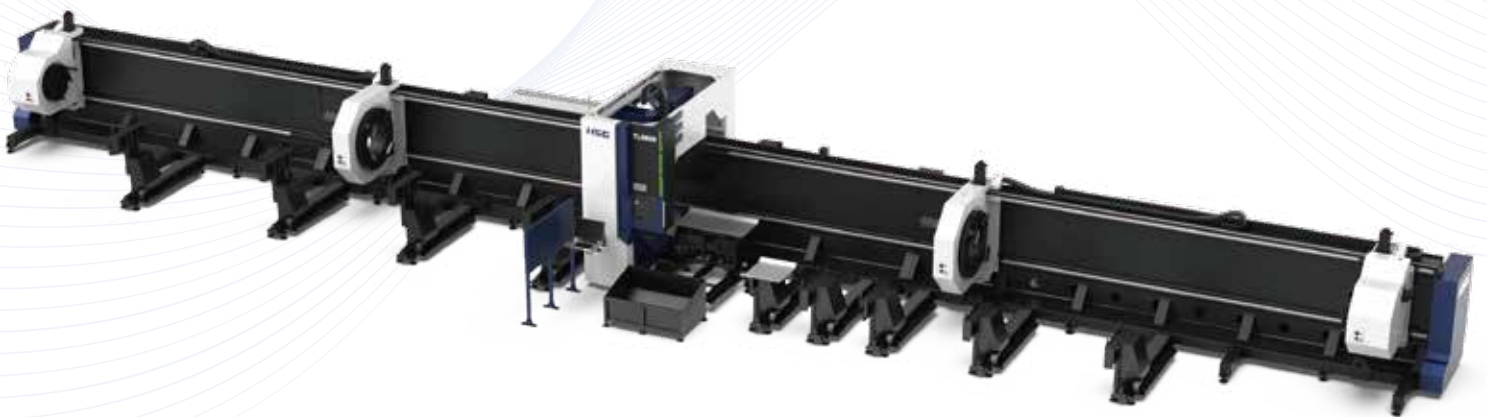

Cutting | Bending | Welding | Automation



TL

❖ Four-chuck Heavy-duty Tube Laser Cutting Machine ❖

Company Culture

MISSION

Intelligent manufacturing changes future

VALUES

Customer-focused and employee-based

VISION

Become a respectable enterprise in the global metal forming equipment field

Company Profile



13

Global Branches



100+

Countries Covered



4

Manufacturing Bases



30+

Global Service Outlets

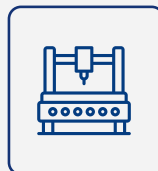

8,000+

Delivery Capability



96,000m²

Occupied Area



TL 6000-12000W

Four-chuck Heavy-duty Tube Laser Cutting Machine

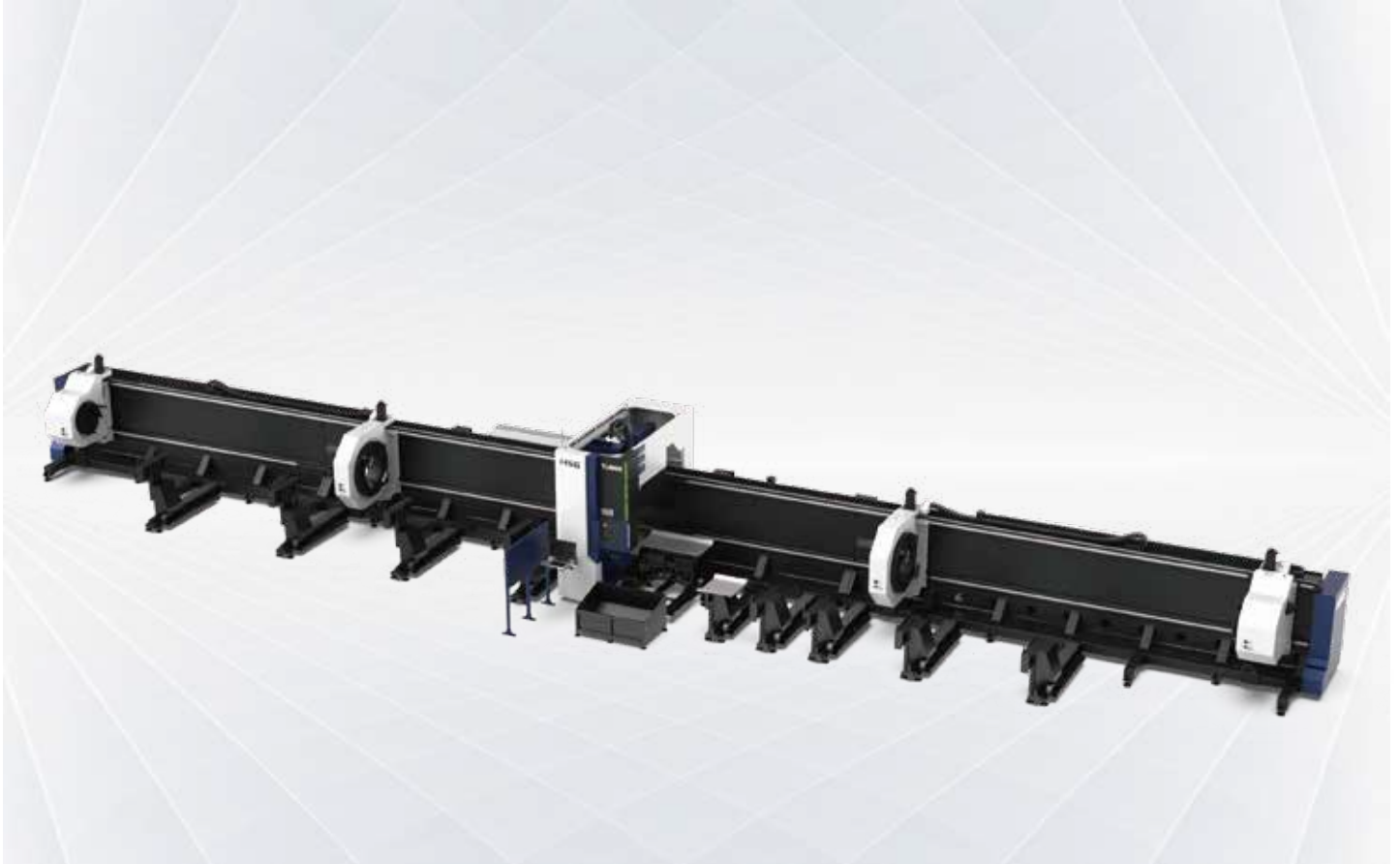

Technical Parameters

Technical Parameter	TL360-12	TL660-12
Power	6000-12000W	6000-12000W
Rotating Speed of Chucks	60r/min	30r/min
No-load Speed	80m/min	50m/min
Max. Linkage Acceleration	0.6G	0.2G
X/Y-axis Positioning Accuracy	±0.05mm/m	±0.01mm/m
X/Y-axis Repositioning Accuracy	±0.05mm	±0.01mm
*Tailing Length	0	0
Cutting Capacity	Round tubeΦ40 - Φ360mm Square tube□40-250mm Diagonal≤360mm and Side Length ≥40mm	Round tubeΦ80 - Φ660mm Square tube□80*80 - □450*450 Diagonal≤660mm and Side Length ≥80mm
Weight of Single Tube	1000kg	3000kg
Overall Dimensions(L*W*H) with Loading Racks	27000*5000*3100mm	29000*6000*4000mm

*Only when the nesting material is reasonable can it be achieved

* Machine appearance, technical parameters, function description, data comparison shown in this page are from HSG in-house laboratory.

All testing results and experimental data shall be subject to real machine.

▶

X9800 Bus-based Tube Cutting Control System

- Simple Interface
Clear interface is convenient for users operating and shows cutting data in real time to save time and costs.
- Functional Integration Control
A number of core functions are showed centrally on the interface to reduce operating steps and users can easily learn to operate.

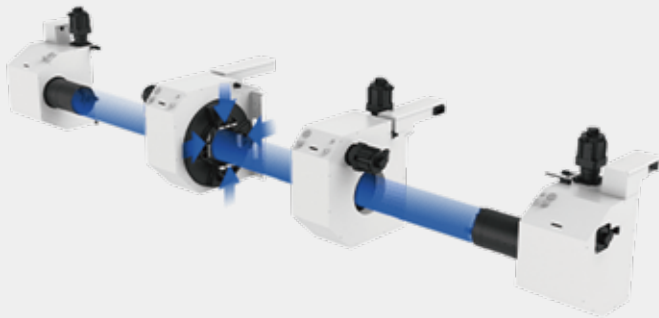
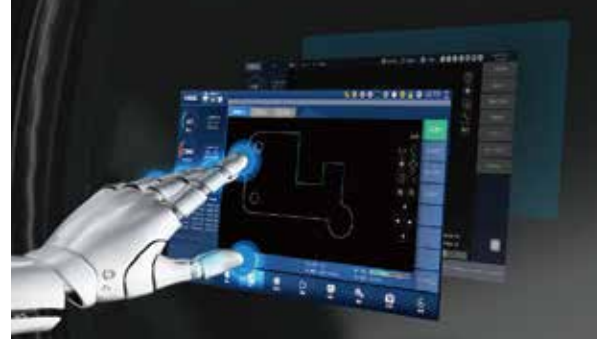

▶

Four Chucks Structure

- HSG launches the first generation of four-chucks heavy-duty tube laser cutting machine in 2019, laying a groundwork for cutting heavy, large and long tube stably.
- Heavy-duty pneumatic chucks for stable clamping .
- Maximum clamping diameter: 500mm (Round Tube).
- Single tube bearing: 1200Kg.

▶

4+1 Full-track Portable Chuck Structure

- Weight Capacity: 4000KG
- Clamping Range

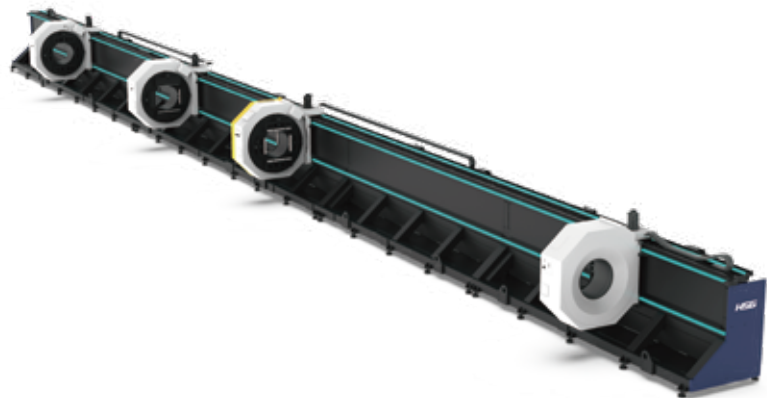

(Model:TL660)

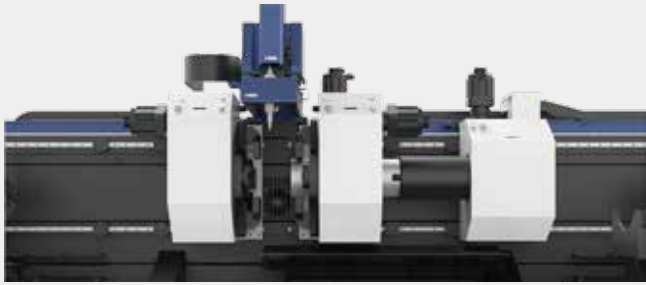

Cut with Short Tailings

- Four chucks combine ordinate cutting with various clamping types to achieve short tailing and improve material utilization ratio.
- Notes: When work procedures are well arranged, zero tailing comes true.



Power-off Cutting Restart Technology Database

- Foreign-imported servo motor contains an absolute encoder to offer power-off cutting restart function, namely, users only need to click to restart the cutting and power failure will not be worried.



Various Tube Processing Functions

- Space leapfrog and fly cutting, in favor of the decrease of idle running of cutting head and the increase of cutting efficiency
Restart to cut from break-point, with less material waste
- Four-side centering for high cutting precision
- Smart typesetting algorithm to enhance material utilization

Machine Foundation

*The marked size has about 10mm error
 *Pictures of TL660 are for reference only and subject to actual dimensions.

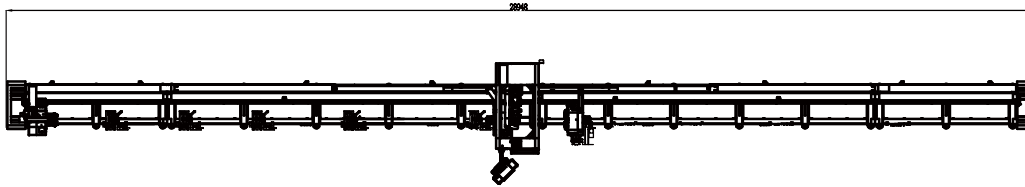
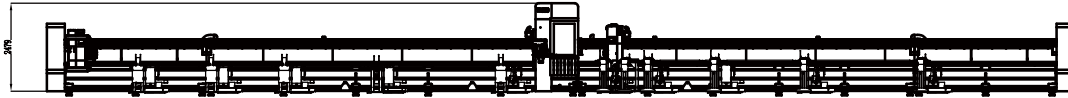
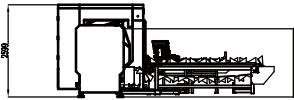

Cutting Samples



Cutting Capacity

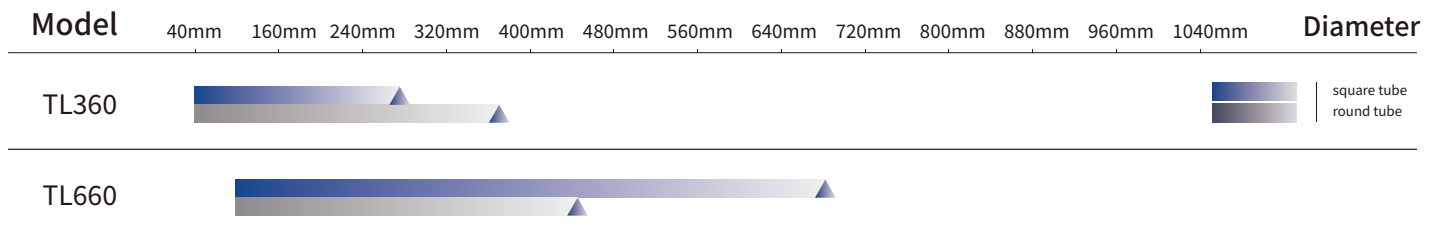

The actual machines shall prevail and above data & pictures are only for reference.



Intelligent Manufacturing Changes Future



As a global enterprise, HSG sticks to providing professional and convenient service support to customers at home and board



Professional Training

Multiple technical training service and free operation training for customers and dealers in time



Efficient Support

Humanistic service model, online services and 7*24 hotline to offer solutions and assistance



Optimized Transport

Multi-channel transport solutions and professional transport solution team will provide various transport cases for to satisfy the demand of customers and save transports fees



Sufficient Accessories

Highly efficient accessories delivery service, multiple network inventory jointly responds to accessories demand to shorten customer's waiting times and accelerate production



Careful Services

Domestic door-to-door service and free proofing, global 100+dealers provide efficient and convenient services



Intelligent Manufacturing Changes Future



Website



Facebook



Youtube

Headquarters Add.: No. 4, Anye Road, Shunjiang Community Industrial Park,
Beijiao Town, Shunde District, Foshan, Guangdong, China
Website: www.hsglaser.com
Email: info@hsglaser.com
Tel: +86 757-66833906